

**Infrared thermometer
for measurement of
smallest temperature
differences of 0.025 °C
(32.05 °F)**

Features:

- New benchmark in low noise IR pyrometry for the measurement of smallest temperature differences of 0.025 °C (32.05 °F)
- Touches the physical limits ensuring low ambient temperature drift
- Green LED alarm indication, aiming support, self diagnostic or temperature code indication
- Scalable analog output: 0 – 5/10 V or 4 – 20 mA (two-wire); additional simultaneous alarm output
- Easy programming via smartphone app (IR mobile) or Windows software (Compact Connect)
- Stainless steel housing with compact dimensions

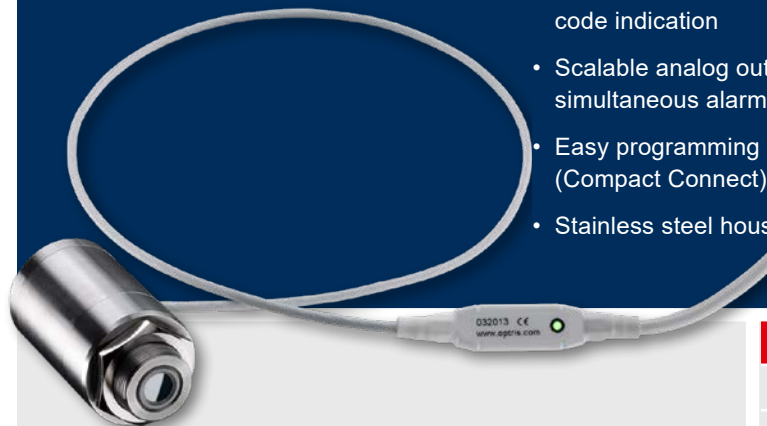

General specifications

Environmental rating	IP 65 (NEMA-4)
Ambient temperature	-20 ... 75 °C (-4 ... 167 °F) (sensing head) -20 ... 80 °C (-4 ... 176 °F) (electronics) -20 ... 75 °C (-4 ... 167 °F) (electronics / mA version) ¹⁾
Storage temperature	-40 ... 85 °C (-40 ... 185 °F)
Relative humidity	10–95 %, non condensing
Vibration	IEC 60068-2-6 / -64
Shock	IEC 60068-2-27 (25 G and 50 G)
Weight	200 g

Electrical specifications

Output / analog	0 – 5 or 10 V or 4 – 20 mA
Output / alarm	0 – 30 V / 50 mA (open collector) (mA version: 500 mA)
Output / digital	Uni-/ bidirectional, 9.6 kBaud, 0/3 V digital level, USB (optional)
LED functions	Alarm indication, automatic aiming support, self diagnostic, temperature indication (via temp. code)
Input (0 – 10 V)	Programmable functional input for external emissivity setting ²⁾ / ambient temperature adjustment ²⁾ , triggered signal output or peak-hold function
Cable length head – electronics: after electronics:	0.5 m (standard) (1.6 ft [standard]) 0.5 m (standard), 3 m, 6 m (1.6 ft [standard], 9.8 ft, 19.7 ft)
Power supply	5–30 V DC
Current draw	9 mA (mV version)

Measurement specifications

Temperature range	-20 ... 150 °C (-4 ... 302 °F)
Spectral range	8–14 μm
Optical resolution (90 % energy)	15:1
CF optics (optional)	3.4 mm @ 50 mm (0.13 in @ 1.97 in)
System accuracy	±1.0 % or ±1.0 °C (±1.8 °F) ^{3), 4)}
Repeatability	±0.3 % or ±0.3 °C (±0.5 °F) ^{3), 4)}
Temperature coefficient	±0.05 K/K or ±0.05 % K ⁵⁾
NETD	0.025 K ⁶⁾
Response time	150 ms
Emissivity / gain (adjustable via software)	0.100 – 1.100
Transmissivity (adjustable via software)	0.100 – 1.100
Signal processing (parameter adjustable only via optional software)	Peak hold, valley hold, average; extended hold function with threshold and hysteresis
Dimensions of electronics	Length: 35 mm Diameter: 12 mm
Software	optris® Compact Connect (Windows) IR mobile (Android)

¹⁾ mA version: For Vcc (supply voltage) 5 – 12 V DC/ the electronic's max. ambient temperature is 65 °C (149 °F) at Vcc > 12 V DC

²⁾ mV version only

³⁾ Object temperature > 20 °C (68 °F); whichever is greater

⁴⁾ At ambient temperature 23 ± 5 °C (73 ± 41 °F)

⁵⁾ At ambient temperatures < 18 °C (< 64 °F) and > 28 °C (> 82 °F); whichever is greater

⁶⁾ At time constant of 150 ms and T_{Obj} 20 °C 68 °F)

optris® CSmicro LT HS

Optical parameters

SF optics, D:S = 15:1

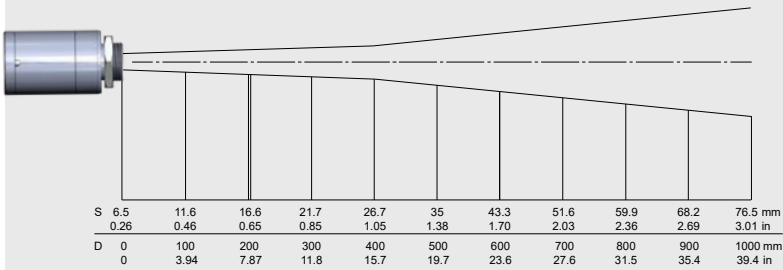

Integrated CF optics, D:S = 15:1 (far field = 5:1)

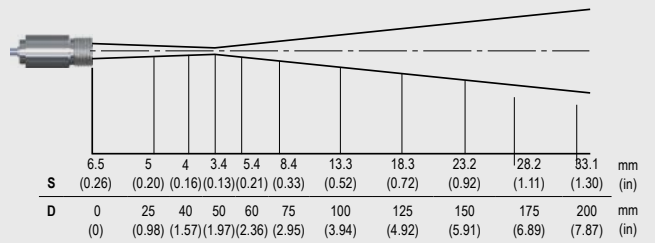

Connections

Connection mV version

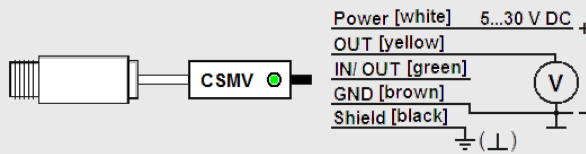

Connection mA version

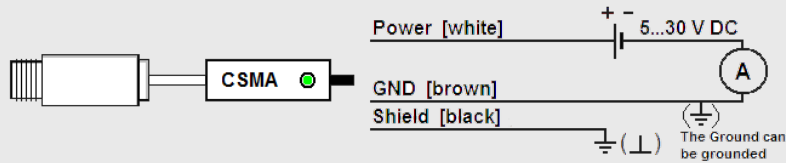

The CSmicro can be connected to a smartphone via the IR app connector



Dimensions

Dimensions CSmicro LT HS

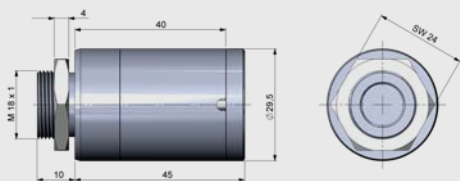

Mounting bracket, fixed (ACCTFBMH)

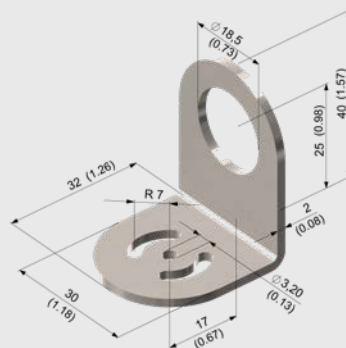

Air purge with integrated CFOptics (ACCTAPMH)

